

Key Features of AXO®-EVB3

- Printed Circuit Board for evaluation of AXO® products
- Includes 1 accelerometer and external passive components
- Plug and Play SPI interface, compatible with Arduino M0 and Yùn
- RS422 and USB interfaces for Arduino boards
- 5V single power supply
- 5V, 3.3V and 1.8V compatibility for communication interface

1. General Description

AXO®-EVB3 evaluation board is intended to easily and quickly perform characterizations of AXO215 accelerometers. AXO®-EVB3 was specially designed to be interfaced with an Arduino M0 or Arduino Yùn boards. The combination of AXO®-EVB3 with the Arduino platform is ideally suited for tests with rate table over the temperature range [-40°C to +85°C].

The 1.8V, 3.3V and 5V compatibility for SPI communication also enables connecting the AXO®-EVB3 with most of the acquisition systems and microcontrollers in the market.

This document describes the mechanical and electrical features of the AXO®-EVB3 board as well as the SPI protocol used for the digital communication. This document is applicable to the whole AXO product line, including AXO215 accelerometers.

For more information about performances of each product, please refer to the dedicated datasheet, available on our [website](#).

2. Mechanical features

The evaluation board has the following dimensions:

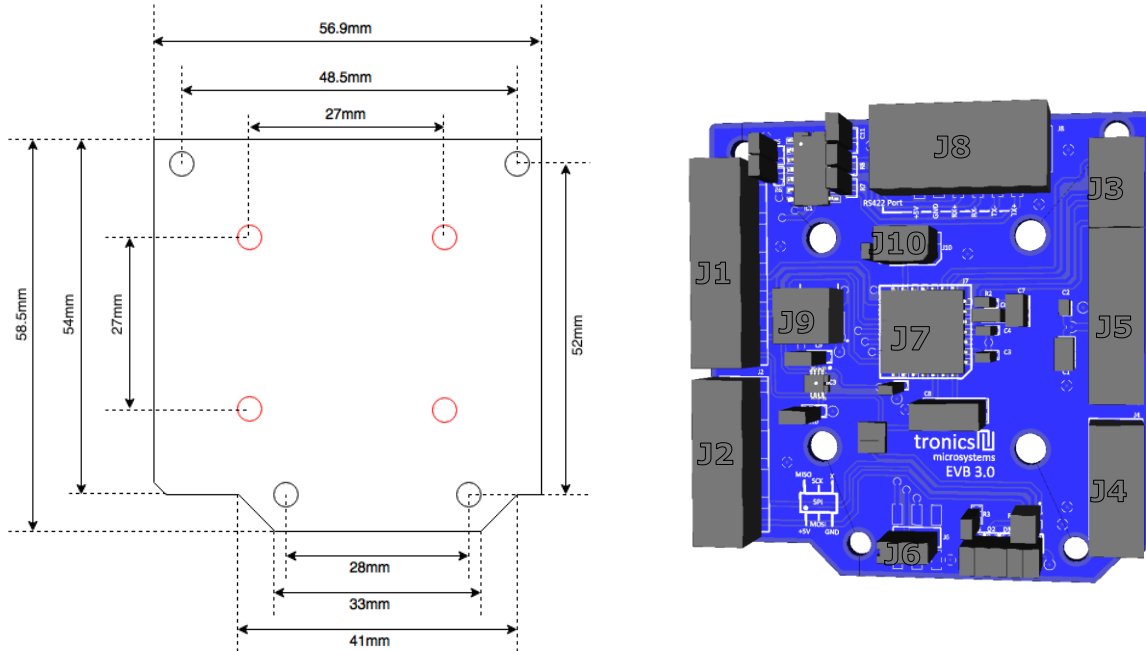

Figure 1: AXO-EVB3 board (unpopulated) dimensions in millimeters with 3D top view

The main AXO®-EVB3 components are described in the table 1:

Name	Description	Information
J1	I/O connector	AXO® I/O signals <ul style="list-style-type: none"> • Enable pin: EN • Self-Test pin: ST • SPI Slave select: SSB • Data Ready pin: DRDY
J2	I/O connector	Arduino UART signals (RX and TX)
J3	I/O connector	Tronics reserved
J4	I/O connector	Not used
J5	I/O connector	Power supply: 5V, VDDIO, GND
J6	I/O connector	Power supply lines: 5V, GND SPI lines: MOSI, MISO, SCLK
J7	AXO® Product	Linear acceleration sensor
J8	I/O connector	RS422 connector (RX+, RX-, TX+, TX-, GND)
J9	I/O connector	SPI level voltage reference: <ul style="list-style-type: none"> • With jumper on +5V : SPI level = +5V • With jumper on 3V3/EXT : SPI level = VDDIO
J10	I/O connector	Sensor reset: <ul style="list-style-type: none"> • Without jumper: no reset • With jumper: reset

Table 1: Main components description

Please note that the PCB has a flat backside and thickness of 1.6 mm. The board has been designed for a direct mounting onto the surface of your test equipment (rate table, vibration shaker...) in order to avoid parasitic mechanical resonance of the PCB.

3. Pins configuration and description

To enable compatibility with the Arduino platform, some signals are redundant, such as 5V and GND signals. If you don't intend to use the Arduino platform, redundancy is not necessary. However the pins marked with bold characters in the tables below must absolutely be connected.

J1 gives access to the following signals:

Pin #	Name	Type	Function
#1	-	-	Not Connected
#2	-	-	Not Connected
#3	-	-	Not Connected
#4	GND	Power	Ground Power Supply
#5	-	-	Not Connected
#6	DRDY	Output	Data Ready pin
#7	SSB	Input	SPI Slave Select pin
#8	-	-	Not Connected
#9	ST	Output	Self-test pin
#10	EN	Input	Enable pin

J2 gives access to the following signals:

Pin #	Name	Type	Function
#1	RX	Input	Arduino UART RX
#2	TX	Output	Arduino UART TX
#3	-	-	Not Connected
#4	-	-	Not Connected
#5	-	-	Not Connected
#6	-	-	Not Connected
#7	-	-	Not Connected
#8	-	-	Not Connected

J3 gives access to the following signals:

Pin #	Name	Type	Function
#1	T0	Output	Tronics Reserved
#2	T1	Output	Tronics Reserved
#3	T2	Output	Tronics Reserved
#4	T3	Output	Tronics Reserved

J4 gives access to the following signals:

Pin #	Name	Type	Function
#1	-	-	Not Connected
#2	-	-	Not Connected
#3	-	-	Not Connected
#4	-	-	Not Connected
#5	-	-	Not Connected
#6	-	-	Not Connected

J5 gives access to the following signals:

Pin #	Name	Type	Function
#1	-	-	Not Connected
#2	-	-	Not Connected
#3	-	-	Not Connected
#4	3V3 / EXT	Power	VDDIO Power Supply
#5	5V	Power	5V Power Supply
#6	GND	Power	Ground Power Supply
#7	GND	Power	Ground Power Supply
#8	-	-	Not Connected

J6 gives access to the following signals:

Pin #	Name	Type	Function
#1	5V	Power	5V Power Supply
#2	MOSI	Input	SPI data input
#3	GND	Power	Ground Power Supply
#4	MISO	Output	SPI data output
#5	SCLK	Input	SPI serial clock
#6	-	-	Not Connected

J8 gives access to the following signals:

Pin #	Name	Type	Function
#1	TX+	Output	Arduino RS422 TX+
#2	TX-	Output	Arduino RS422 TX-
#3	RX-	Input	Arduino RS422 RX-
#4	RX+	Input	Arduino RS422 RX+
#5	GND	Power	Ground Power Supply
#6	5V	Power	Ground Power Supply

For more information about the RS422 interface and its use, please refer to the dedicated technical notes, available on our [website](#)

4. Electrical circuit

The following figure presents the electrical schematic of the board with its passive components (resistors & capacitances).

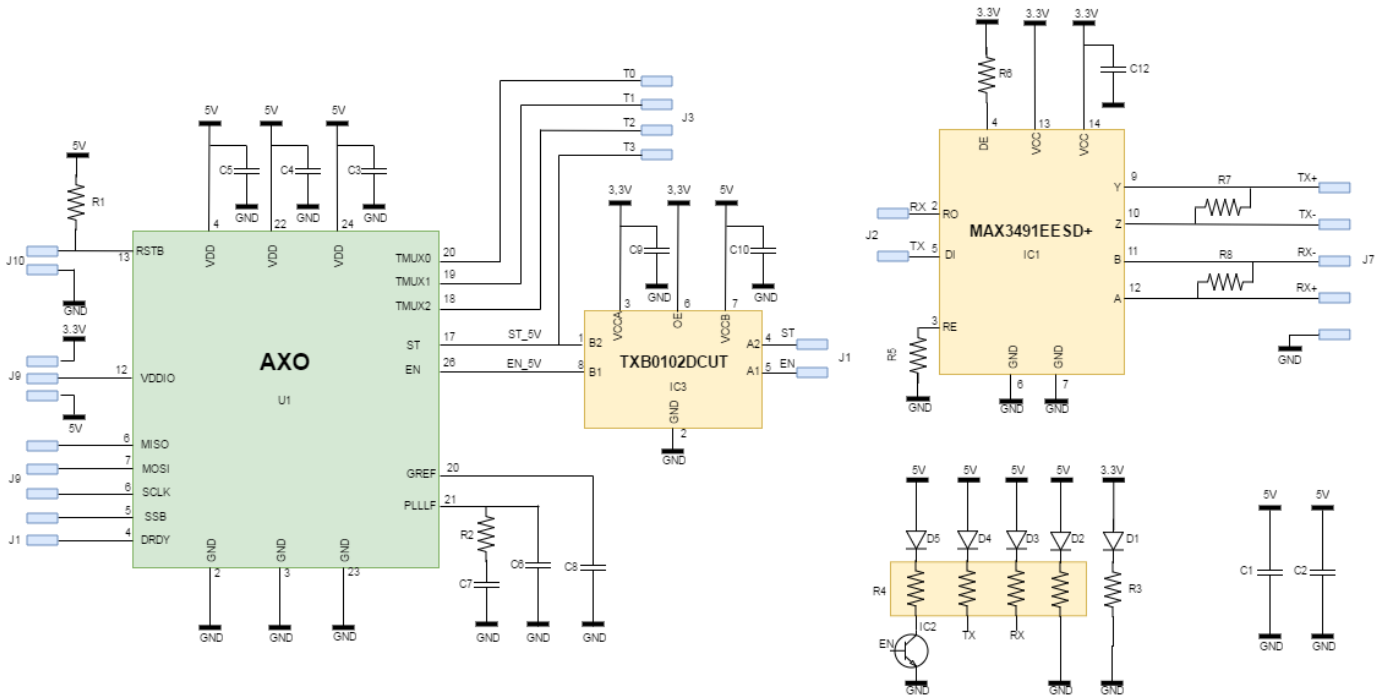

Figure 2: Electrical schematic

5. Electrical Characteristics

Parameter	Min	Typical	Max	Units
5V Power Supply (VDD)	4.75	5	5.25	V
Reference Voltage (VDDIO)	1.8	-	5	V
Current consumption ¹⁾		25		mA
Output		Digital 24 bits		-
Digital interface		SPI		-

1) The specified value represents the typical current consumption of AXO® products.

Table 2: Electrical characteristics

For more information about advanced use of AXO® product, please refer to the dedicated AXO® datasheet, available on our [website](#)

Caution!



The product may be damaged by ESD, which can cause performance degradation or device failure! We recommend handling the device only on a static safe work station. Precaution for the storage should also be taken.

The sensor **MUST** be powered-on *before* any SPI operation. Having the SPI pads at a high level while VDD is at 0V could damage the sensor, due to ESD protection diodes and buffers.

6. Environment













Environmental specifications for AXO® accelerometers and AXO®-EVB3 are the following:

Parameter	Condition	Min	Typ	Max	Units
Operating temperature range		-40		+85	°C
Humidity	At 45°C			98	%

Table 3: Environmental specifications

7. Available Tools and Resources

The following tools and resources are available on [AXO®](#) webpage of Tronics website.

Item	Description
Documentation & technical notes	
	AXO215 - Flyer
	AXO215 - Datasheet
Mechanical tool	
	AXO215 - 3D model
Evaluation kit	
	AXO®-EVB3 – Evaluation board <i>Evaluation board for AXO215, compatible with Arduino M0 and Arduino Yùn</i>
	GYPRO®-EVB2 – Evaluation board <i>Evaluation board for GYPRO2300, 2300LD and 3300, compatible with Arduino M0 and Arduino Yùn</i>
	Tronics Evaluation Tool – Software
	AXO®-EVB3 – User manual
	Tronics Evaluation Kit – Quick Start Guide
	Tronics Evaluation Tool – Software User Manual
	Tronics Evaluation Tool – Installation Tutorial
	Tronics Evaluation Tool – Software Tutorial
	Tronics Evaluation Tool – Arduino Firmware